



D1

Model: I21D01

User Manual, Safety, Warranty and Info Guide

Introduction

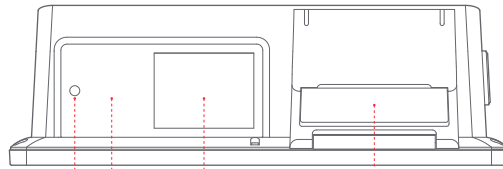

Camera
NFC (Optional) Secondary LCD Display
Printer

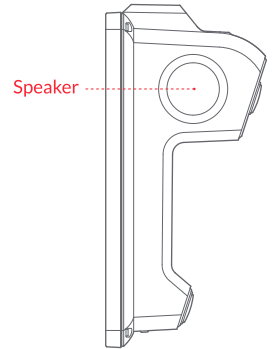
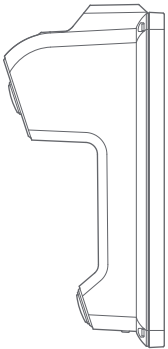

Speaker

Reset
Power Button
Volume +
Volume -
Main LCD Display

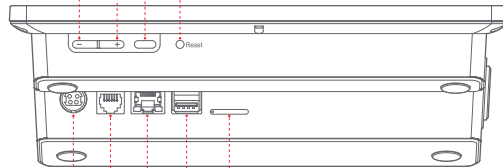

DC-in Jack
RJ12 Port
RJ45 Port
SIM Card Slot
Type-A USB Port x2

Printer User Guide

- 1 Unscrew the printer cover and the paper compartment door pops open;

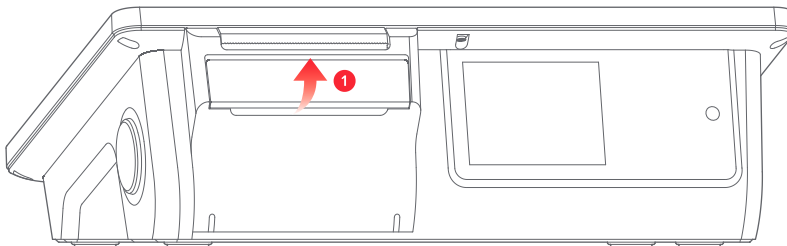

- 2 Insert the thermal paper and pull out part of it outside the paper exit of the printer, then close the paper compartment cover;

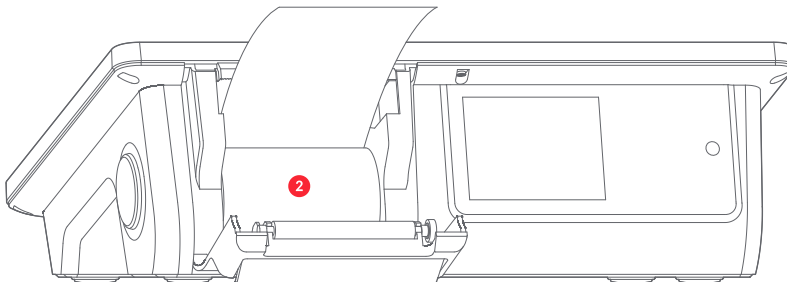

- 3 After printing, tear the paper upwards.

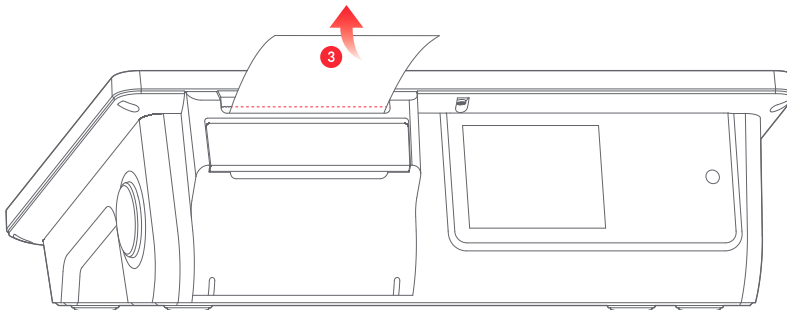

Technical Specifications

OS	Android 11 Go Edition (suitable for 2GB RAM)/ Android 11 (suitable for 4GB RAM)
CPU	8-Core, 2 x A75 and 6 x A55, 1.8GHz
Main LCD Display	10.1 inches, resolution: 800 x 1280, multi-touch capacitive screen
Secondary LCD Display	2.4 inches, resolution: 240 x 320
Storage	2GB RAM (optional 4GB) + 16GB ROM
Camera	0.3M, FF
Wi-Fi	Support 802.11a/b/g/n/ac
Bluetooth	5.0BLE
Card Slot	2 x SIM
Network	2G/3G/4G
NFC	Optional, default none
Printer	58mm thermal printer, support the paper roll with maximum 40mm diameter
Speaker	1.5W
External Interface	1 x DC-in, 1 x RJ12 (12-24V), 1 x RJ45, 2 x Type-A port, 1 x SIM Card Slot
Power Adapter	Output power 36W, Input: AC100~240V/1.5A, Output: DC24V/1.5A
Machine Size	250.2mm x 171.9mm x 80.5mm
Operating Temperature	0°C to +50°C
Storage Temperature	-20°C to +60°C
Operating Humidity	10% to 90% r.H.
Limit Altitude	Max. 5000 meters

Name and Content of Toxic and Harmful Substances in This Product

Part Name	Toxic or Harmful Substances and Elements					
	Plumbum (Pb)	Mercury (Hg)	Cadmium (Cd)	Chromium VII (Cr(VII))	Polybrominated biphenyl (Cr(VII))	Polybrominated diphenyl ethers (PBDE)
Circuit Board	×	○	○	○	○	○
Head of Printer	×	○	○	○	○	○

○: Means that the content of the toxic and harmful substances in all homogeneous materials of the component is below the limit specified in SJ/t113363-2006.

×: Means that the content of the toxic and hazardous substances at least in a homogenous material of the component exceeds the limit specified in SJ/t113363-2006. However, the components marked with "×" in the above table are out of proportion because there is no mature alternative technology in the industry at present.

Products that have reached or exceeded the environmental protection service life should be recycled and reused in accordance with the electronic information products control and management measures or local environmental laws and guidelines. They should not be discarded at will or with household waste.

Product Warranty Card

Model No.: I21D01

Serial No.: _____

Purchase Date: _____

Warranty Period: The warranty period commences on the date of purchase. We offer 365 days warranty service.

User Phone: _____

User Address: _____

iMin does not warrant against the following:

- Disassembled or repaired product by unauthorised service provider without our consent.
- Damaged product barcode, fragile sticker and altered or defective warranty card.
- Damage caused by non-compliance with instructions in this user manual.
- Damage caused by exposure to sources of liquid, dripping or splashing, normal wear and tear, accident or abuse.
- Failure or damage as a result of any Force Majeure Event.
- Expired warranty period.

Packing Content

- Device x 1
- Power Adapter x 1, Power Cable x 1
- Printing Paper x 1, Ejector Pin x 1
- User Manual x 1

Qualification Certificate
Passed Inspection

Safety Information

Safety and Handling

- Please plug-in power adapter to only its corresponding AC socket.
 - Do not use in explosive gas atmosphere.
 - Do not disassemble the equipment. It should be serviced or recycled only by iMin or an authorised service provider.
 - This is a Grade B product. The product may cause radio interference and interfere with medical devices. The user may be required to take practical measures to reduce the possibility of causing interference to radios, televisions and other electronic devices.
 - About the battery replacement:
 1. Do not attempt to replace the battery yourself - you may damage the battery, which could cause overheating, fire and injury.
 2. The replaced/ used battery should be disposed according to local environmental laws and guidelines. Do not dispose in fire. It should be serviced or recycled by iMin or an authorised service provider, and must be recycled or disposed of separately from household waste.
-

Company Statement

Our company is not responsible for the following actions:

- Damage caused by misuse, lack of care in maintaining the equipment, or placing the device under conditions that may cause undesired operation and risk as specified in this instruction manual.
- We will not be responsible for any damage or problem caused by third party parts or components (other than the original products or approved products provided by us). Without our consent, you have no right to modify or alter the products.
- The operating system of this product is supported by official regular OS update. If the user breached the third party's ROM system or change the system file by hacking, it may cause unstable, undesired system operation and bring security risk.

Advices

- Do not expose the device to moisture, dampness, or wet weather, such as rain, snow or fog.
 - Do not use the device in extreme cold or hot environments eg, near a fire or lit cigarette.
 - Do not topple, throw, or bend.
 - Use in optimally clean and dust-free environment to avoid tiny particles clogging and seeping through gaps in the device.
 - Do not attempt to use the device near medical equipment.
-

Important Safety Information

- Do not install or use during thunder storms and lightning conditions, otherwise, there will be risk of electric shock, injury or death in the event of thunder or lightning hit.
 - If you find unusual odour, overheating or smoke, please cut off the power immediately.
 - Do not expose the device to moisture, dampness, or wet weather, such as rain, snow or fog; Do not use in explosive gas atmosphere.
-

Disclaimer

Due to regular updates and enhancements made to the product, some details of this document may be inconsistent with the physical product. Please take the product you received as current standard. The right to interpret this document belongs to our company. We reserve the right to amend this specification without prior notice.



3-06-10-994